

Daelshof Show 2016

Showmanship (alle Klassen)

Show Date: 16.07.2016

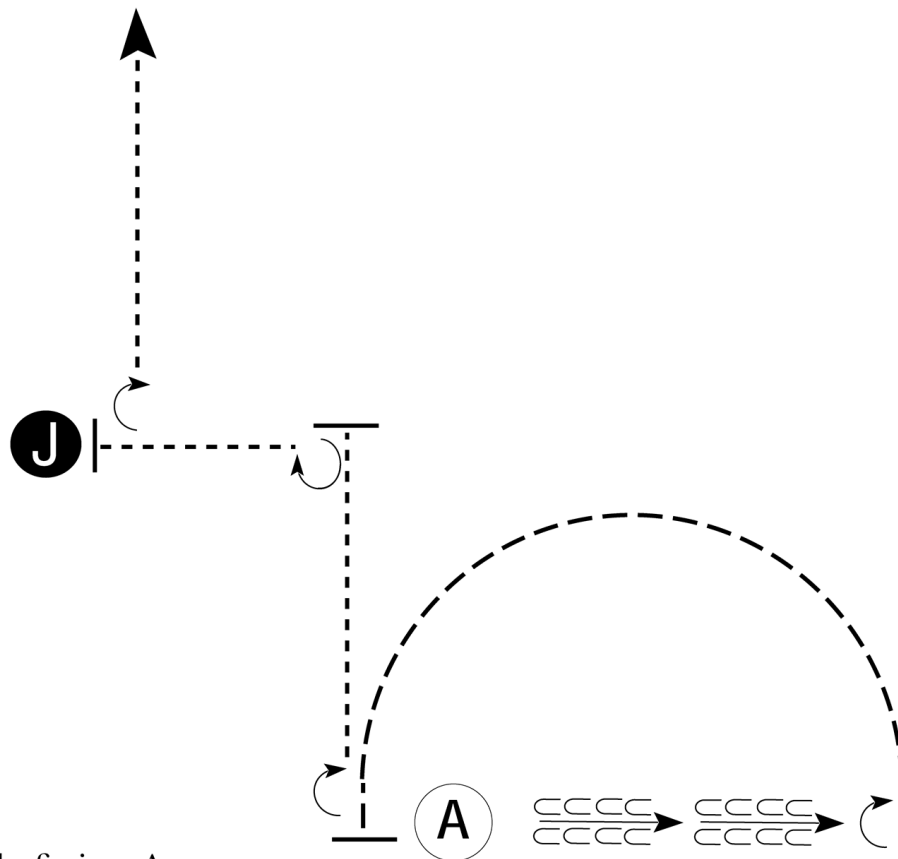

Be ready facing A.

1. When acknowledged, back approximately 2 horse lengths.
2. Perform a 90 degree turn.
3. Trot a half circle back to A.
4. Stop and perform a 180 degree turn.
5. Walk until your horse's hip is even with Judge.
6. Stop and perform a 270 degree turn.
7. Walk to judge. Stop and set up for inspection.
8. When dismissed, perform a 90 degree turn.
9. Walk straight away from judge.

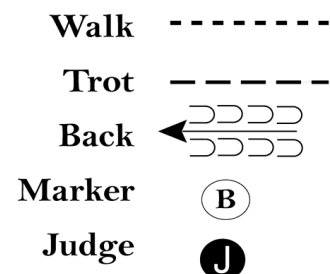

Follow the instructions of your ring steward.

[S/2-67]

Pattern Provided by:

Juergen von Bistram

Daelshof Show 2016

Hunt Seat Equitation (alle Klassen)

Show Date: 16.07.2016

w w w . H o r s e S h o w P a t t e r n s . c o m

w w w . H o r s e S h o w P a t t e r n s . c o m

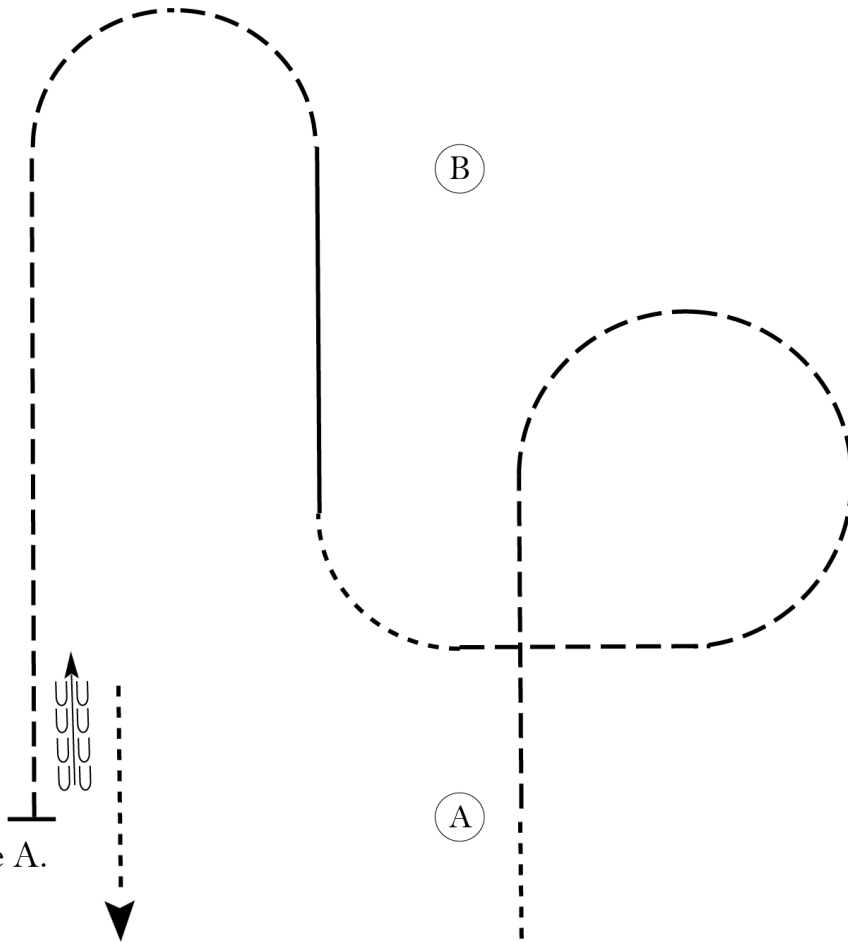

Be ready before A.

1. Walk to A.
2. Sitting trot halfway to B.
3. Left diagonal trot in a $\frac{3}{4}$ circle until even with A.
4. Walk a quarter circle.
5. Canter on the left lead to B.
6. When even with B, trot on the right diagonal in a half circle and a straight line until even with A.
7. Halt when even with A and back approximately one horse length.
8. Walk to exit.

Follow the instructions of your ring steward.

Walk	-----
Trot	- - - - -
Extended Trot	-----
Canter	—————
Leg Yield	
Lead Change	↙ ↘
Back	←←←←←
Marker	⊙
Sidepass	←---→
Hand Gallop	—————

[HSE/2-59]

Pattern Provided by:

Juergen von Bistram

Daelshof Show 2016

Trail (Trail In Hand / Walk Trot TH)

Show Date: 16.07.2016

www.HorseShowPatterns.com

www.HorseShowPatterns.com

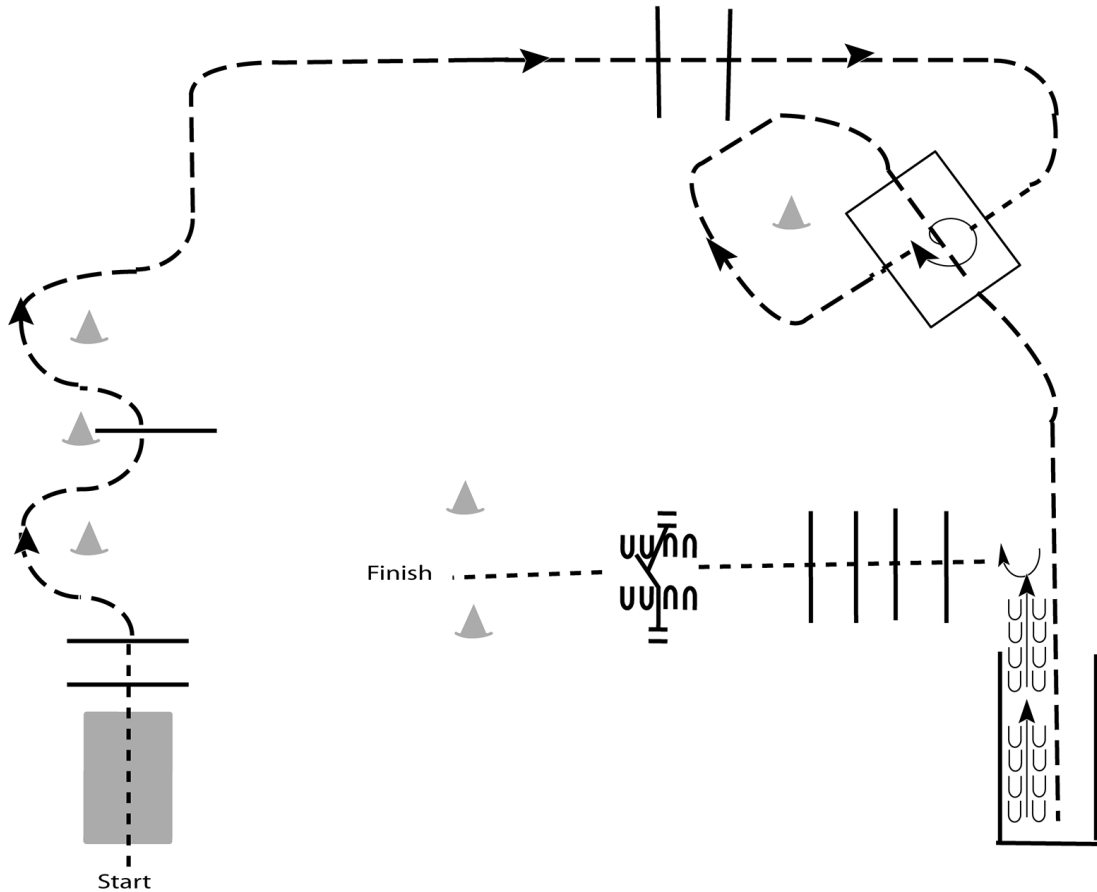

1. Walk over bridge and over poles.
2. Jog through serpentine and over pole.
3. Continue to jog over poles.
4. Break to a walk and walk into box. Turn a full turn to the right and walk out of box.
5. Jog through box and into chute
6. Back out of chute
7. Turn 90 degrees and walk over poles to gate
8. Work gate and walk to finish

Walk	-----
Jog	- - - - -
Extended Jog	- - - - -
Lope	—————
Leg Yield	
Lead Change	— / —
Back	← ← ← ← ←
Marker	Ⓚ
Sidepass	← ——— →

[T/1-6]

Pattern Provided by:

Juergen von Bistram

Daelshof Show 2016

Trail (L1 Amateur / Green Open)

Show Date: 16.07.2016

www.HorseShowPatterns.com

www.HorseShowPatterns.com

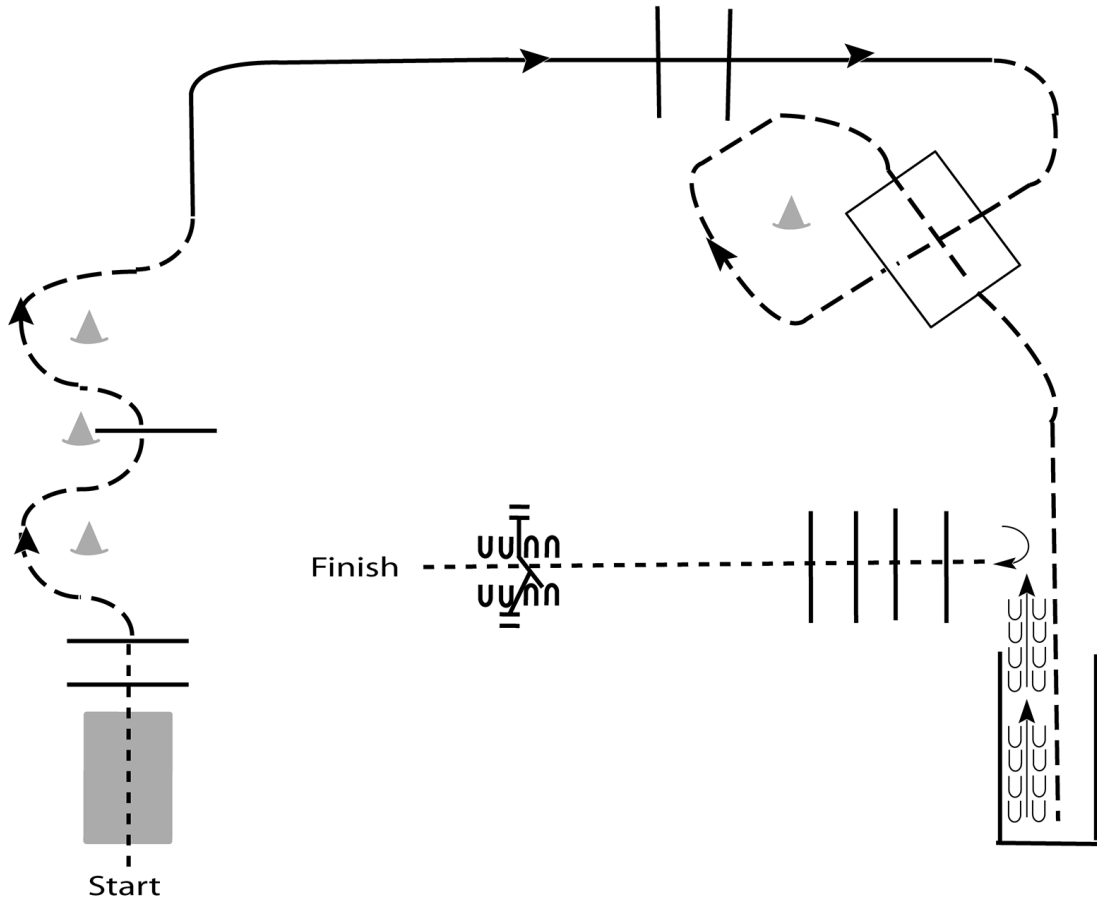

Be ready at start.

1. Walk over bridge and over poles.
2. Jog through serpentine and over pole.
3. Lope on the right lead over poles.
4. Jog through box and into chute.
5. Back out of chute.
6. Turn 90 degrees and walk over elevated poles.
7. Work gate with left hand.

Walk	-----
Jog	-----
Extended Jog	-----
Lope	-----
Leg Yield	
Lead Change	---/---
Back	←←←←←
Marker	Ⓚ
Sidepass	←-----→

[T/1-6]

Pattern Provided by:

Juergen von Bistram

Daelshof Show 2016

Trail (Amateur / Rasseoffen)

Show Date: 16.07.2016

www.HorseShowPatterns.com

www.HorseShowPatterns.com

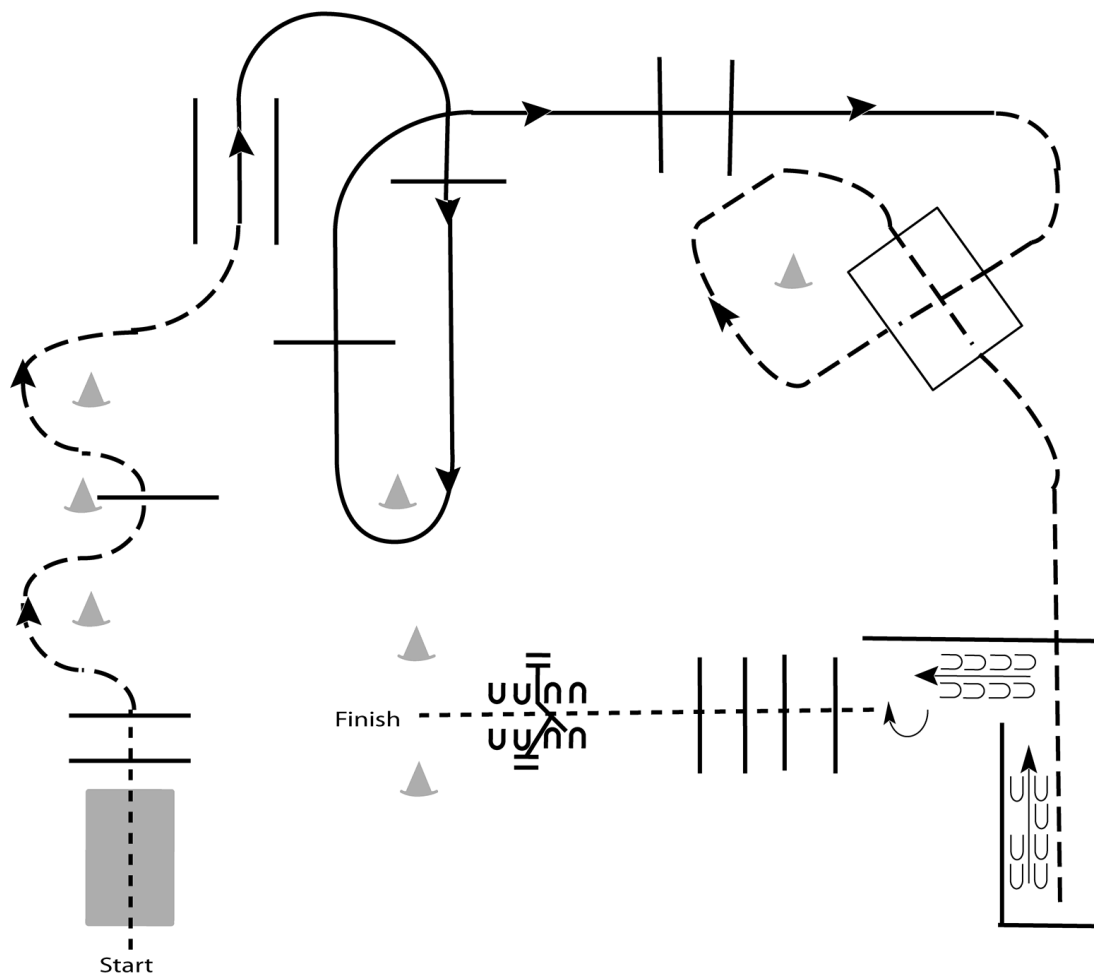

Begin at Start.

1. Walk over bridge and over poles.
2. Jog through serpentine and over pole.
3. Lope on the right lead over poles.
4. Jog through box and into chute.
5. Back the L.
6. Turn 180 degrees and walk over elevated poles.
7. Work gate with left hand.

Walk	-----
Jog	-----
Extended Jog	-----
Lope	—————
Leg Yield	
Lead Change	—/—
Back	←←←←
Marker	ⓑ
Sidepass	←-----→

[T/2-7]

Pattern Provided by:

Juergen von Bistram

Daelshof Show 2016

Trail (Open)

Show Date: 16.07.2016

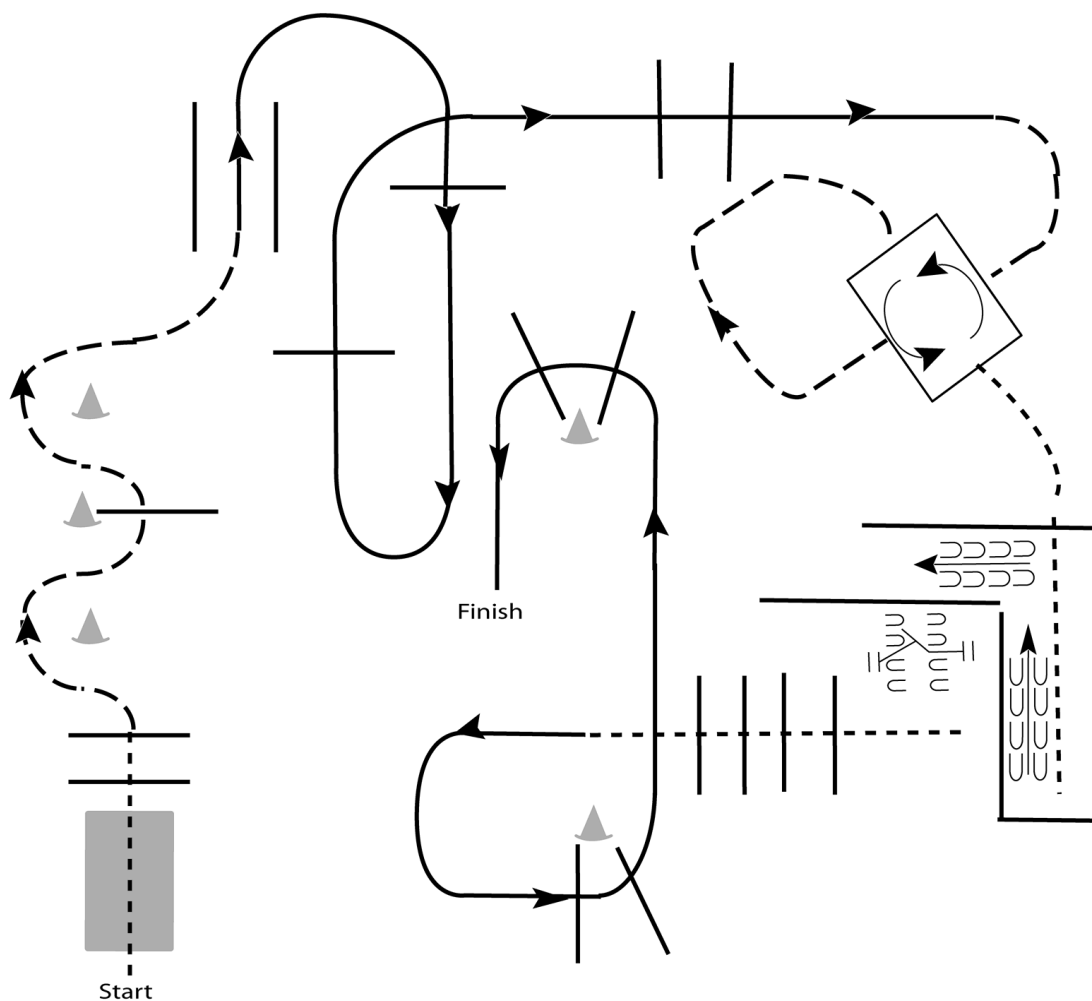

1. Walk over bridge and over poles
2. Jog through serpentine and over pole
3. Lope on the right lead over poles
4. Jog through box, then jog into box
5. Turn 360 degrees to the left in the box
6. Walk out of box and into chute
7. Back the L
8. Work the gate
9. Walk over poles
10. Lope on the left lead over poles to finish

Walk	-----
Jog	-----
Extended Jog	-----
Lope	—————
Leg Yield	
Lead Change	—/—
Back	←←←←←
Marker	ⓑ
Sidepass	←-----→

[T/3-4]

Pattern Provided by:

Juergen von Bistram

www.HorseShowPatterns.com

www.HorseShowPatterns.com

Daelshof Show 2016

Western Riding (L1 Amateur / Green Open)

Show Date: 16.07.2016

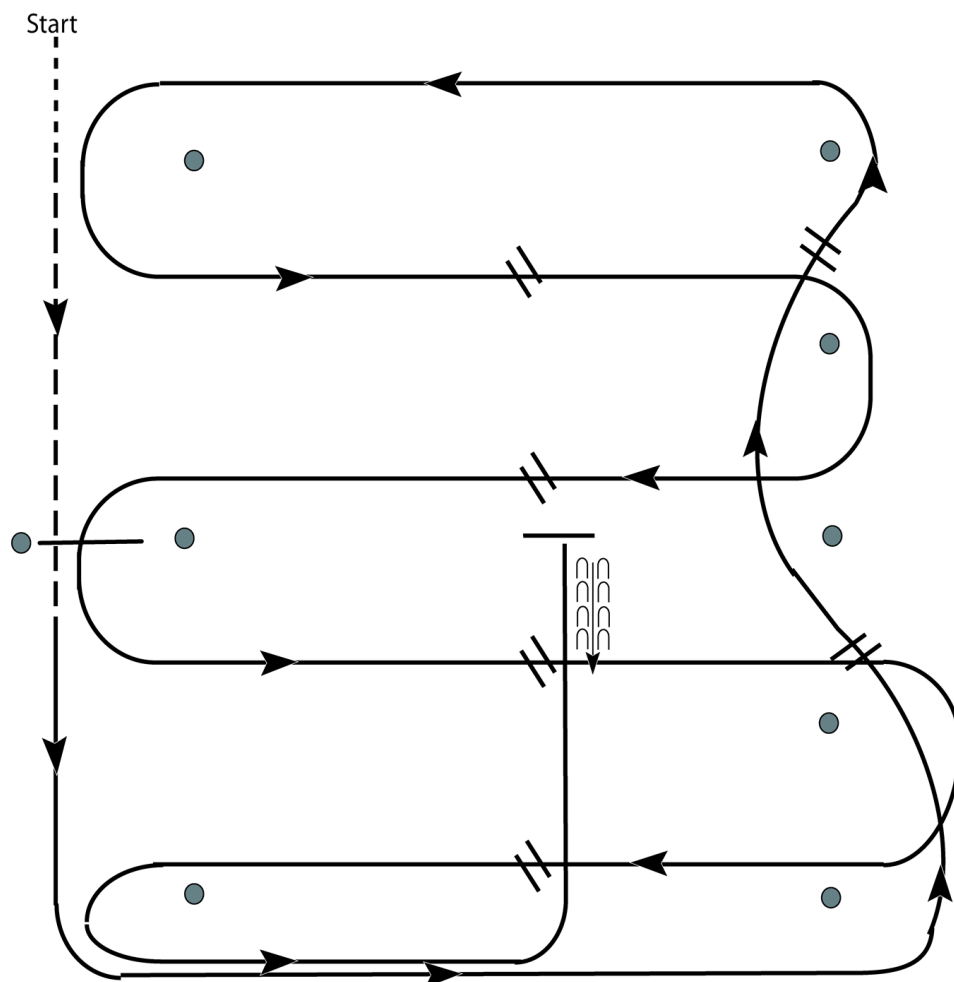

1. Walk at least 15' & jog over log.
2. Transition to left lead and lope around end.
3. First line change.
4. Second line change. Lope around end of arena
5. First crossing change.
6. Second crossing change.
7. Lope over log.
8. Third crossing change.
9. Fourth crossing change.
10. Lope up the center, stop and back.

[WR/GP-1]

Pattern Provided by:

Juergen von Bistram

Daelshof Show 2016

Western Riding (Amateur / Open)

Show Date: 16.07.2016

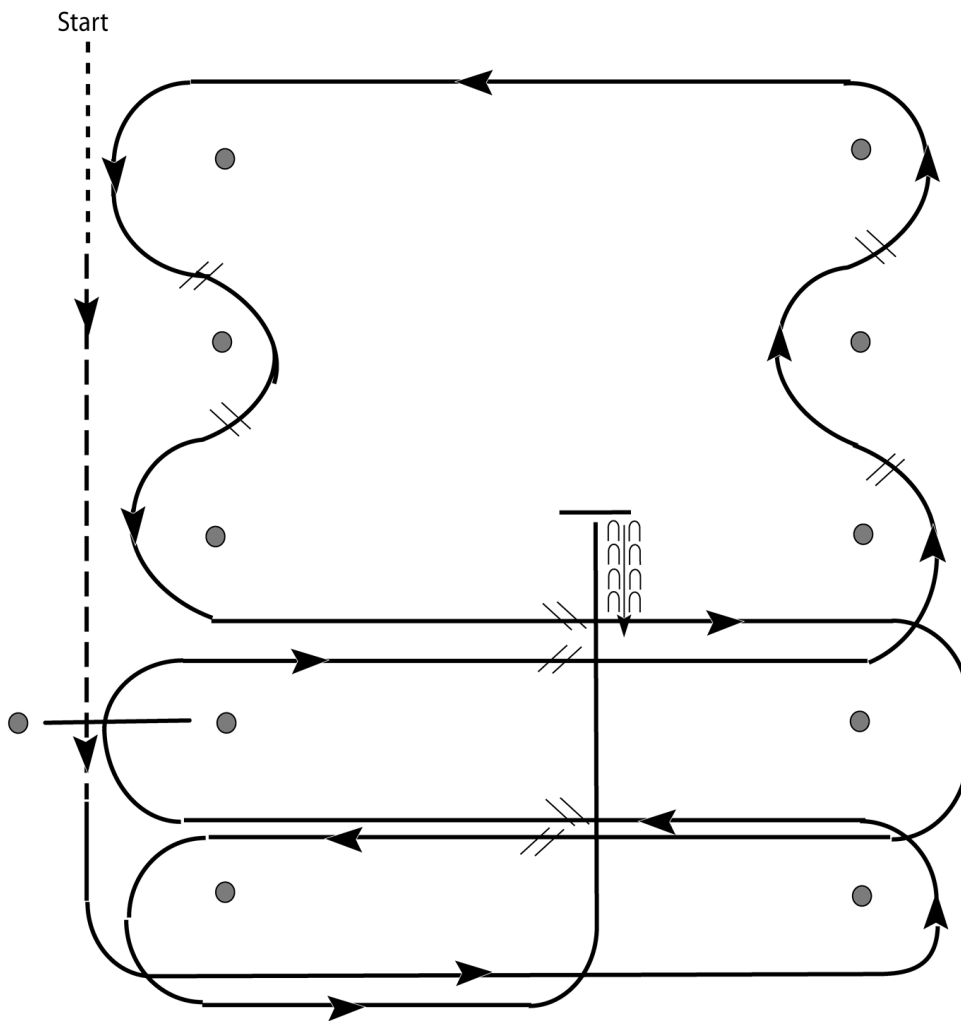

1. Walk, transition to jog, jog over log.
2. Transition to left.
3. First crossing change.
4. Lope over log.
5. Second crossing change.
6. First line change.
7. Second line change.
8. Third line change.
9. Fourth line change.
10. Third crossing change.
11. Fourth crossing change.
12. Lope up the center, stop and back.

[WR/OP-3]

Pattern Provided by:

Juergen von Bistram

Daelshof Show 2016

Western Horsemanship (Walk Trot)

Show Date: 16.07.2016

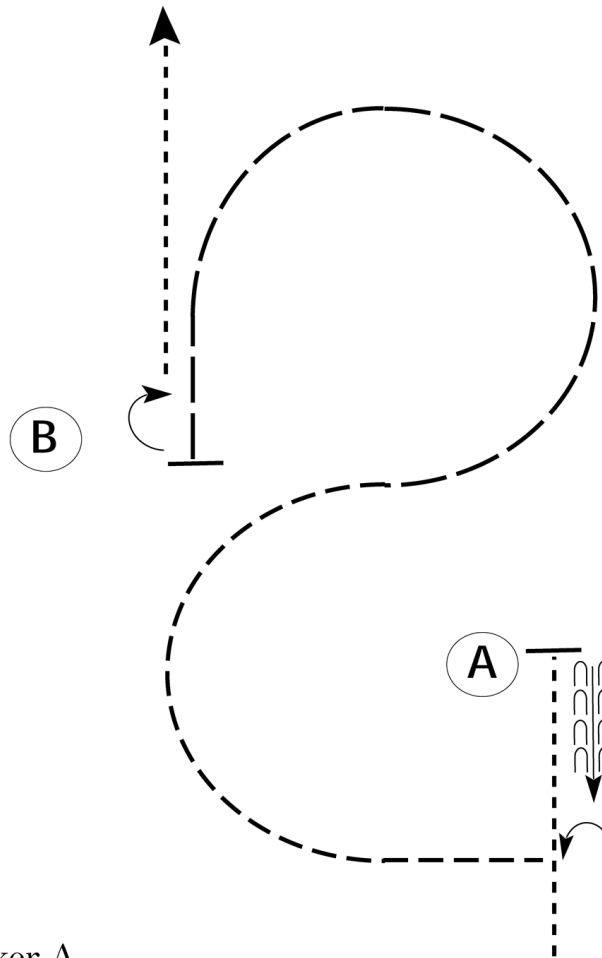

Be ready before marker A.

1. Walk to A.
2. Stop and back approximately one horse length.
3. Execute a 1/4 turn to the left and jog a half circle.
4. Extend the jog to B.
5. Stop at B and execute a 1/2 turn to the right.
6. Walk to exit.

Follow the instructions of your ring steward.

Walk	-----
Jog	- - - - -
Extended Jog	- - - - -
Lope	—————
Leg Yield	
Lead Change	— / —
Back	← — — — — — — — — —
Marker	Ⓚ
Sidepass	← — — — — →

[WH/WT-68]

Pattern Provided by:

Juergen von Bistram

w w w . H o r s e S h o w P a t t e r n s . c o m

w w w . H o r s e S h o w P a t t e r n s . c o m

Daelshof Show 2016

Western Horsemanship (L1 Amateur / Rasseoffen)

Show Date: 16.07.2016

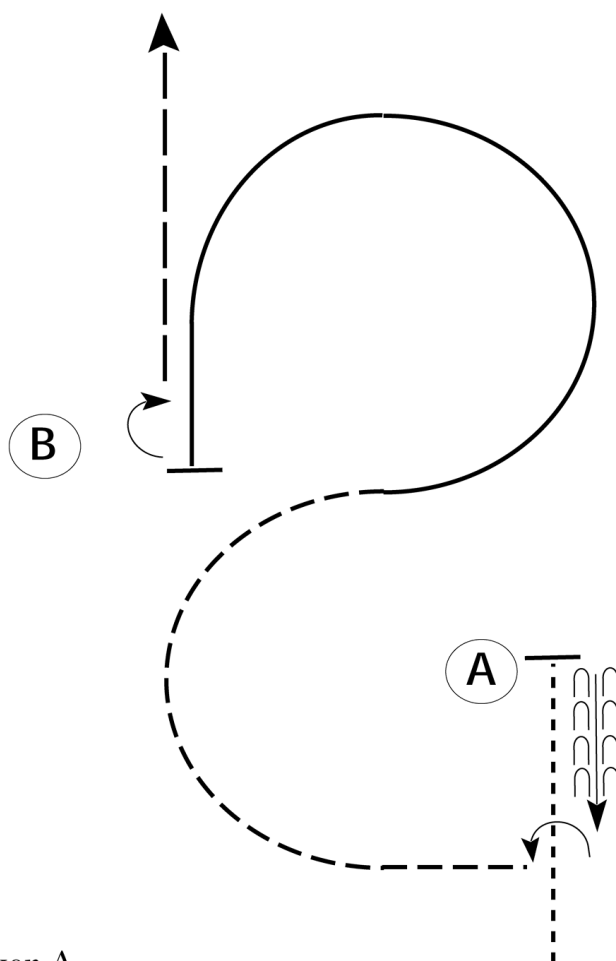

Be ready before marker A.

1. Walk to A.
2. Stop and back approximately one horse length.
3. Execute a 1/4 turn to the left and jog a half circle.
4. Lope on the left lead to B.
5. Stop at B and execute a 1/2 turn to the right.
6. Extend the jog to exit.

Follow the instructions of your ring steward.

Walk	-----
Jog	- - - - -
Extended Jog	- - - - -
Lope	—————
Leg Yield	
Lead Change	— / —
Back	← — — — — — — — — —
Marker	ⓑ
Sidepass	← — — — — →

[WH/1-68]

Pattern Provided by:

Juergen von Bistram

w w w . H o r s e S h o w P a t t e r n s . c o m

w w w . H o r s e S h o w P a t t e r n s . c o m

Daelshof Show 2016

Western Horsemanship (Amateur)

Show Date: 16.07.2016

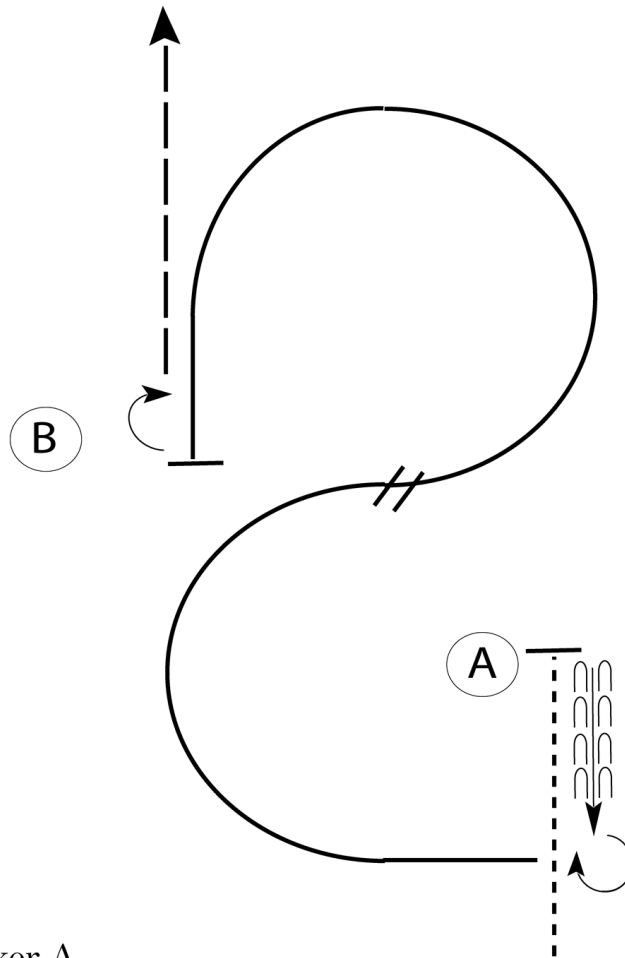

Be ready before marker A.

1. Walk to A.
2. Stop and back approximately one horse length.
3. Execute a 3/4 turn to the right and lope on the right lead.
4. Perform a simple lead change and lope on the left lead to B.
5. Stop at B and execute a 1/2 turn to the right.
6. Jog to exit.

Follow the instructions of your ring steward.

Walk	-----
Jog	- - - - -
Extended Jog	- - - - -
Lope	—————
Leg Yield	
Lead Change	↙ ↘
Back	← ⊂ ⊂ ⊂ ⊂ ⊂
Marker	⊙ B
Sidepass	← ——— →

[WH/2-68]

Pattern Provided by:

Juergen von Bistram

Daelshof Show 2016

Ranch Riding (alle Klassen)

Show Date: 16.07.2016

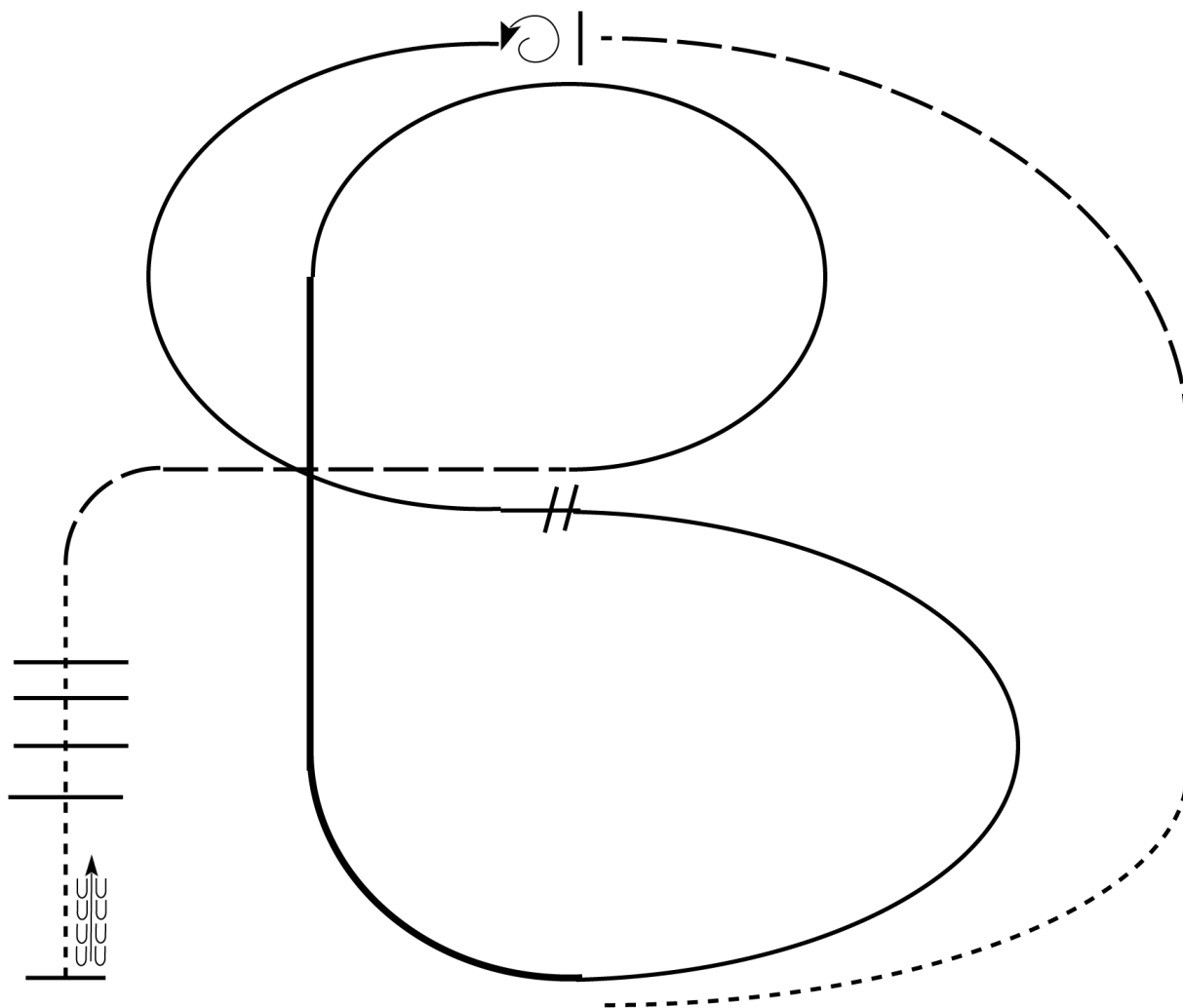

1. Walk
2. Trot
3. Extend the trot, at the top of the arena, stop
4. 360 degree turn to the left
5. Left lead 1/2 circle, lope to the center
6. Change leads (simple or flying)
7. Right lead 1/2 circle
8. Extended lope up the long side of arena (right lead)
9. Collect back to a lope around the top of the arena and back to center
10. Break down to an extended trot
11. Walk over poles.
12. Stop and back

Walk	-----
Jog	- - - - -
Extended Jog	-----
Lope	
Lead Change	//
Back	←
Marker	(B)

[RR/1]

Pattern Provided by:

Juergen von Bistram

w w w . H o r s e S h o w P a t t e r n s . c o m

w w w . H o r s e S h o w P a t t e r n s . c o m

Daelshof Show 2016

Reining (L1 Amateur / Green Open)

Show Date: 16.07.2016

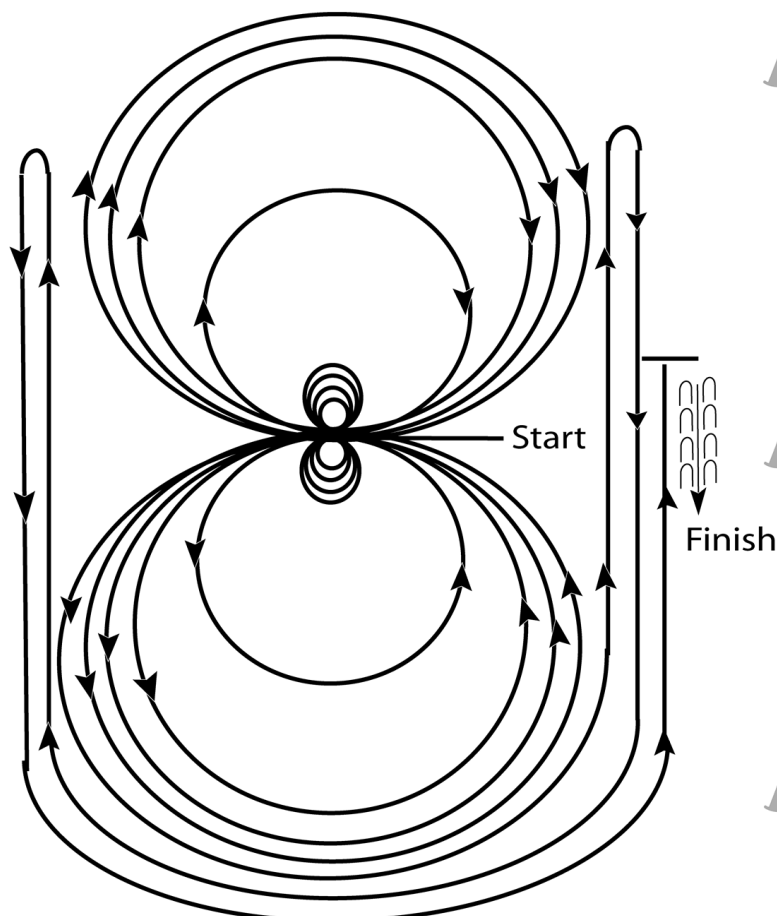

Horses must walk or stop prior to starting pattern. Beginning at the center of the arena facing the left wall or fence.

1. Beginning on the left lead, complete three circles to the left: the first two circles large and fast; the third circle small and slow. Stop at the center of the arena.
 2. Complete four spins to the left. Hesitate.
 3. Beginning on the right lead, complete three circles to the right: the first two circles large and fast; the third circle small and slow. Stop at the center of the arena.
 4. Complete four spins to the right. Hesitate.
 5. Beginning on the left lead, run a large fast circle to the left, change leads at the center of the arena, run a large fast circle to the right, and change leads at the center of the arena.
 6. Continue around previous circle to the left but do not close this circle. Run up the right side of the arena past the center marker and do a right rollback at least twenty feet (6.09m) from the wall or fence – no hesitation.
 7. Continue around previous circle but do not close this circle. Run up the left side of the arena past the center marker and do a left rollback at least twenty feet (6.09m) from the wall or fence – no hesitation.
 8. Continue back around previous circle but do not close this circle. Run up the right side of the arena past the center marker and do a sliding stop at least twenty feet (6.09m) from the wall or fence. Back up at least ten feet (3m). Hesitate to demonstrate completion of the pattern.
- Rider may drop bridle to the designated judge.

[R/AQHAP-5]

Pattern Provided by:

Juergen von Bistram

Daelshof Show 2016

Reining (Amateur / Rasseoffen)

Show Date: 16.07.2016

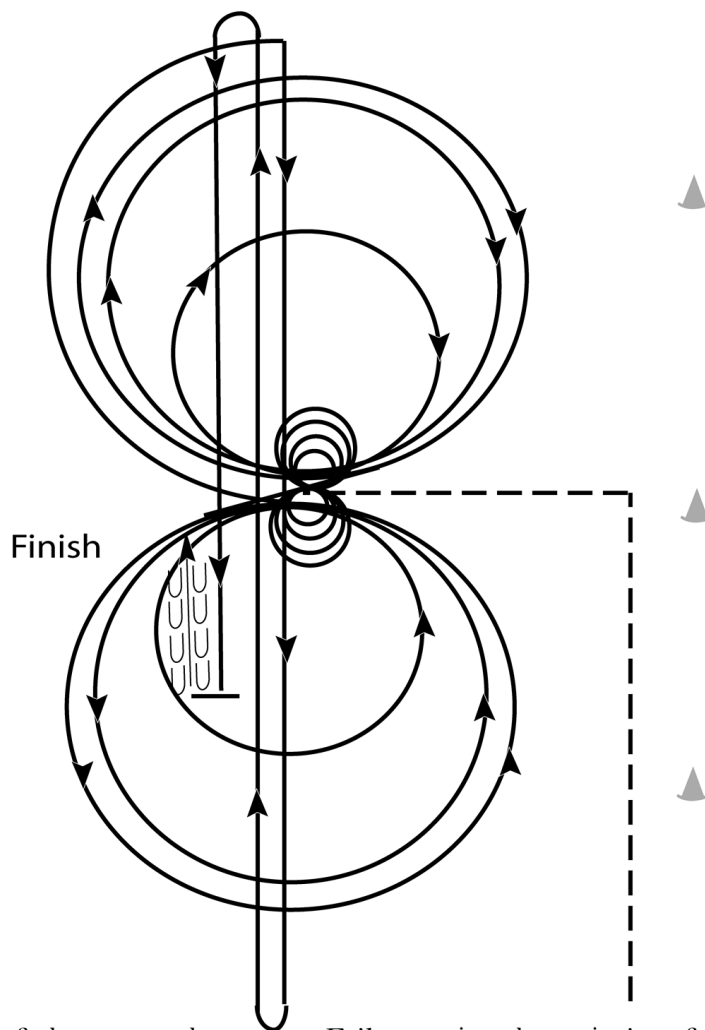

Horses must jog the majority of the way to the center. Failure to jog the majority of the way to the center will result in a 0 for failure to complete the pattern as written. Horses must wal or stop prior to starting pattern. Begin at the center of the arena facing the left wall or fence.

1. Complete four spins to the left. Hesitate.
2. Complete four spins to the right. Hesitate.
3. Beginning on the right lead, complete three circles to the right; the first small and slow; the next two circles large and fast. Change leads at the center of the arena.
4. Complete three circles to the left; the first small and slow; the next two circles large and fast. Change leads at the center of the arena.
5. Begin a large circle to the right, but do not close this circle. Run down the center of the arena past the end marker and do a right rollback - no hesitation. C
6. Run up the middle to the opposite end of the arena past the end marker and do a left rollback - no hesitation.
7. Run past the center marker and do a sliding stop. Back up to the center of the arena or at least 10 feet (3m). Hesitate to demonstrate completion of pattern.

[R/AQHAP-11]

Pattern Provided by:

Juergen von Bistram

Daelshof Show 2016

Reining (Open)

Show Date: 16.07.2016

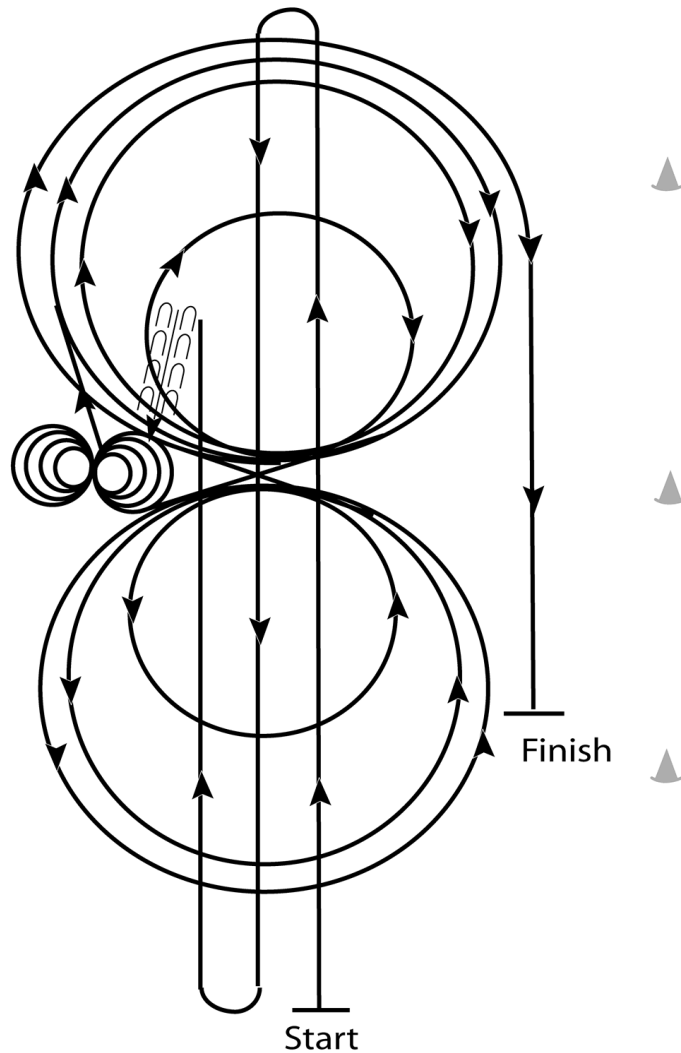

1. Run at speed to the far end of the arena past the end marker and do a left rollback – no hesitation.
2. Run to the opposite end of the arena past the end marker and do a right rollback – no hesitation.
3. Run past the center marker and do a sliding stop. Back up to the center of the arena at least ten feet (3m). Hesitate.
4. Complete four spins to the right.
5. Complete four and one-quarter spins to the left so that horse is facing left wall or fence. Hesitate.
6. Beginning on the right lead, complete three circles to the right: the first two circles large and fast; the third circle small and slow. Change leads at the center of the arena.
7. Complete three circles to the left: the first two circles large and fast; the third circle small and slow. Change leads at the center of the arena.
8. Begin a large fast circle to the right but do not close this circle. Run straight down the right side of the arena past the center marker and do a sliding stop at least twenty feet (6.09m) from the wall or fence. Hesitate to demonstrate completion of the pattern.
Rider may drop bridle to the designated judge.

[R/AQHAP-7]

Pattern Provided by:

Juergen von Bistram